

8POL

N????

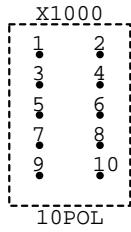

10POL

X????

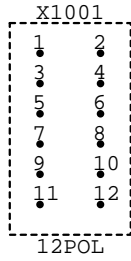

12POL

X????

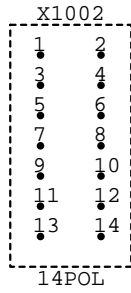

14POL

X????

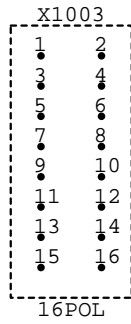

16POL

X????

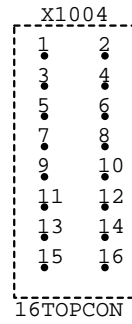

16TOPCON

16TCON

X????

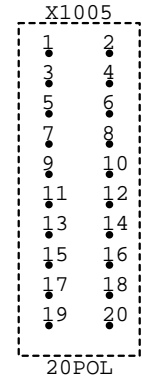

20POL

X????

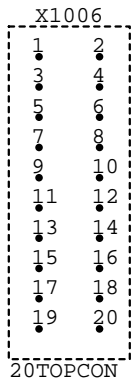

20TOPCON

X????

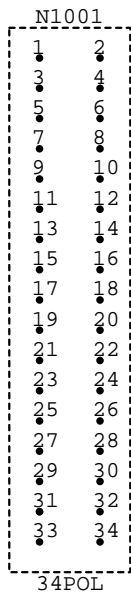

34POL

N????

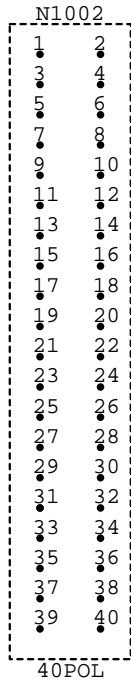

40POL

N????

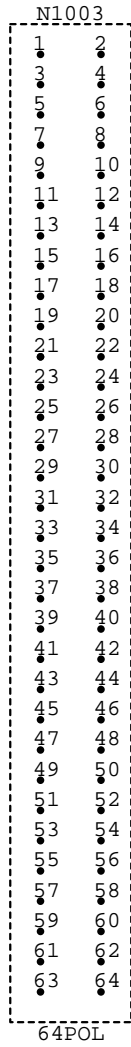

64POL

N????

N1004

1	2
3	4
5	6
7	8
9	10
11	12
13	14
15	16
17	18
19	20
21	22
23	24
25	26
27	28
29	30
31	32
33	34
35	36
37	38
39	40
41	42
43	44
45	46
47	48
49	50
51	52
53	54
55	56
57	58
59	60
61	62
63	64
65	66
67	68
69	70
71	72
73	74
75	76
77	78
79	80
81	82
83	84
85	86

86POL

86POL  
N????

X1007

1	2
3	4
5	6
7	8
9	10
11	12
13	14
15	16
17	18

AMP185683

AMP\_185683  
X????

N1005

1
2
3
4
5
6
7
8

QLOK8

AMPQLOK8  
N????

N1006

A1
A2
A3
A4
A5
A6
A7
A8
A9
A10
A11
A12
A13
A14
A15
A16
A17
A18
A19
A20
A21
A22
A23
A24
A25
A26
A27
A28
A29
A30
A31
\$plname

ATCONA

ATCONA  
N????

N1007

B1
B2
B3
B4
B5
B6
B7
B8
B9
B10
B11
B12
B13
B14
B15
B16
B17
B18
B19
B20
B21
B22
B23
B24
B25
B26
B27
B28
B29
B30
B31
\$plname

ATCONB

ATCONB  
N????

N1008

A1
A2
A3
A4
A5
A6
A7
A8
A9
A10
A11
A12
A13
A14
A15
A16
A17
A18
A19
A20
A21
A22
A23
A24
A25
A26
A27
A28
A29
A30
A31
\$rpname

ATFINGA

ATFINGA  
N????

N1009

B1
B2
B3
B4
B5
B6
B7
B8
B9
B10
B11
B12
B13
B14
B15
B16
B17
B18
B19
B20
B21
B22
B23
B24
B25
B26
B27
B28
B29
B30
B31
\$rpname

ATFINGB

ATFINGB  
N????

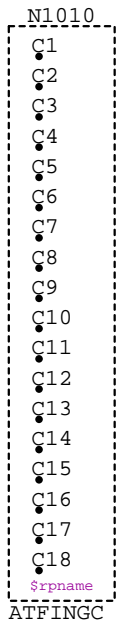

ATFINGC

ATFINGC

N????

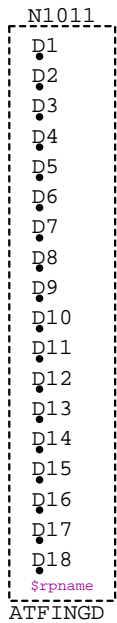

ATFINGD

ATFINGD

N????

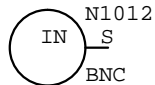

BNC

N????

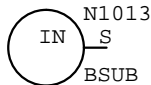

BNCSUB

N????

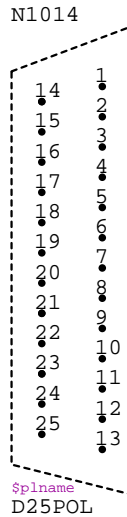

D25POL

D25POL

N????

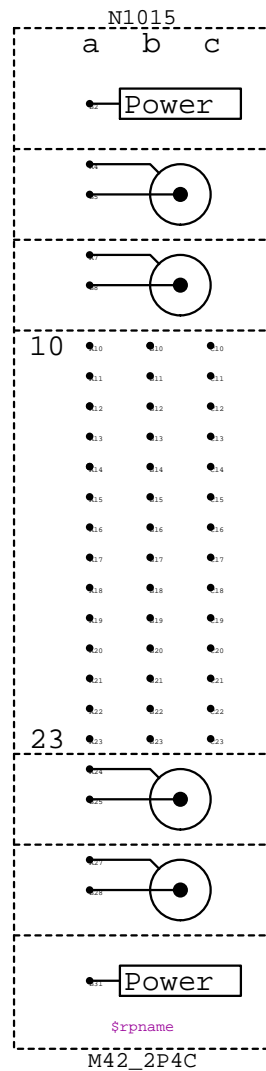

M42\_2P4C

M42\_2P4C

N????

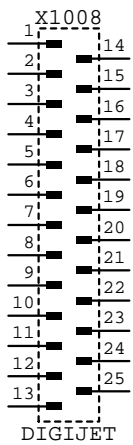

MCONDJ25

X????

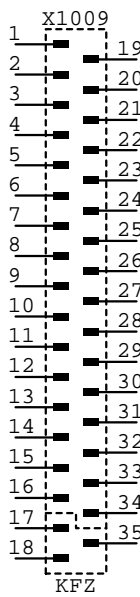

MOTCON35

X????

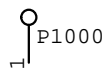

MP

P????

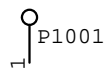

MP\_

P????

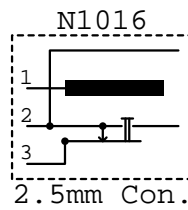

POW25CON

N????



POWCON\_6MM

X???

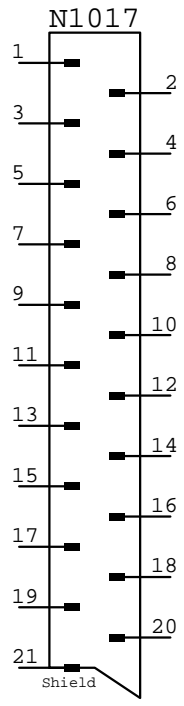

X  
M5  
C X101

SCART

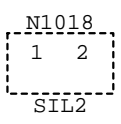

N1018  
SIL2

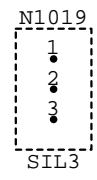

N1019  
SIL3

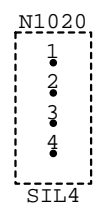

N1020  
SIL4

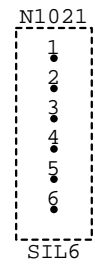

N1021  
SIL6

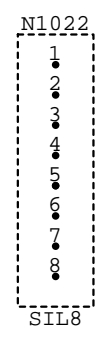

N1022  
SIL8

POWCON\_M5  
X????

SCARTCON  
N?????

SIL2  
N?????

SIL3  
N?????

SIL4  
N?????

SIL6  
N?????

SIL8  
N?????

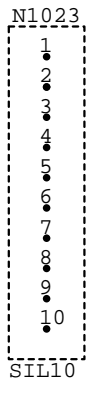

N1023  
SIL10

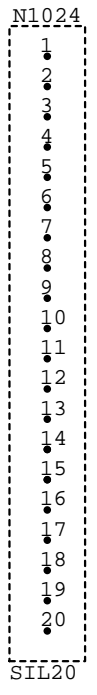

N1024  
SIL20

SIL10  
N?????

SIL20  
N?????

N1025

- 1
- 2
- 3
- 4
- 5
- 6
- 7
- 8
- 9
- 10
- 11
- 12
- 13
- 14
- 15
- 16
- 17
- 18
- 19
- 20
- 21
- 22
- 23
- 24
- 25
- 26
- 27
- 28
- 29
- 30
- 31
- 32

SIL32

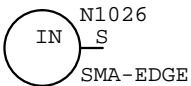

N1026  
SMA-EDGE

SIL32

SMA\_EDGE

N????

N????

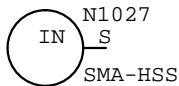

N1027  
SMA-HSS

SMA\_HS45111

N????

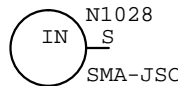

N1028  
SMA-JSC

SMA\_JS1420711

N????

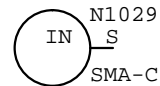

N1029  
SMA-C

SMACASECON

N????

N1032

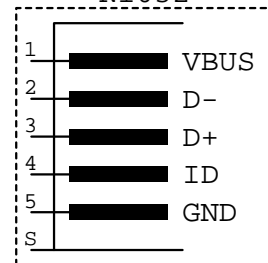

USB Mini B

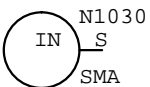

N1030  
SMA

SMACON

N????

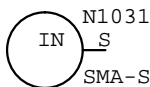

N1031  
SMA-S

SMASIDECON

N????



P1002  
TP

TP

P????



P1003  
TPAD

TPAD

P????



TP10  
TPC

TPC

TP??

USB\_MINIB\_SMD

N????

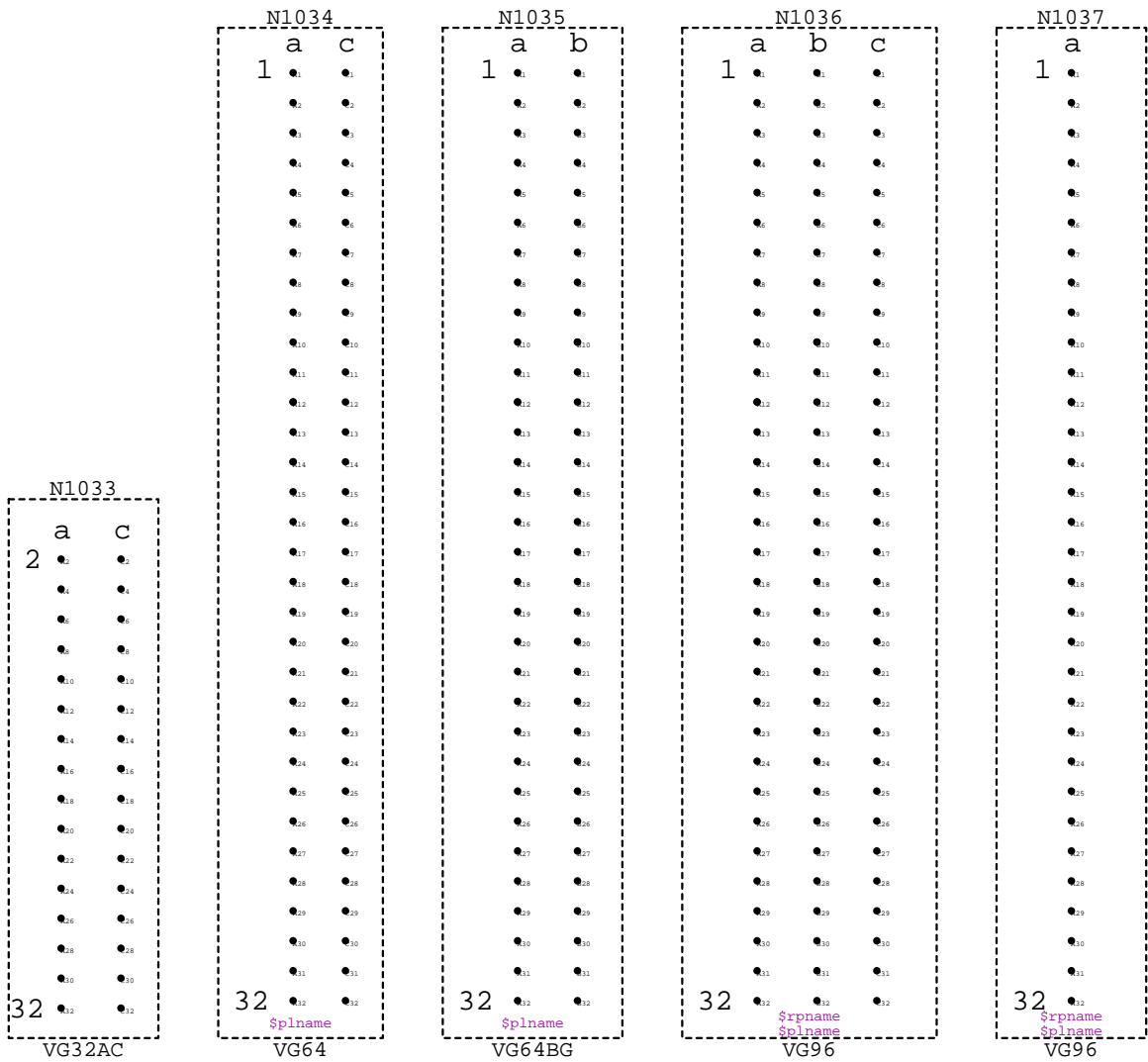

VG32AC

VG64

VG64BG

VG96

VG96\_A

N????

N????

N????

N????

N????

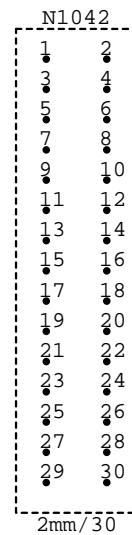
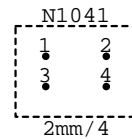
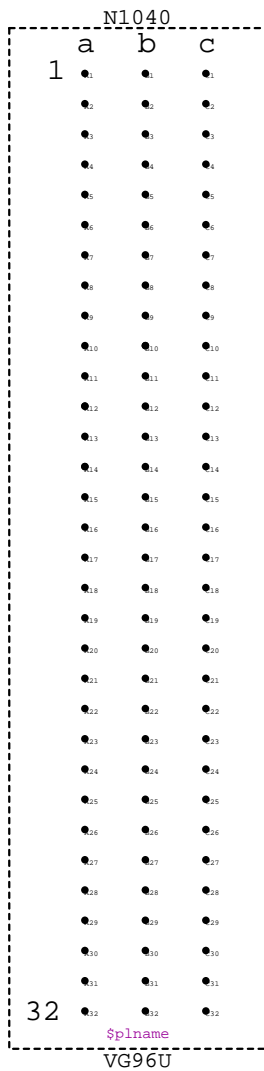
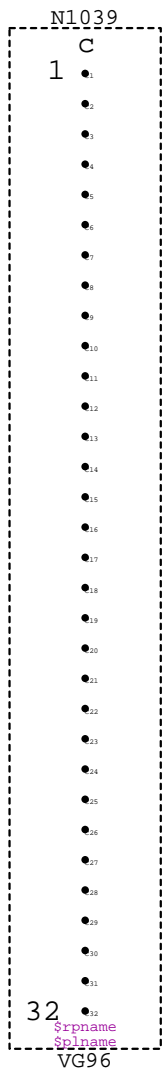
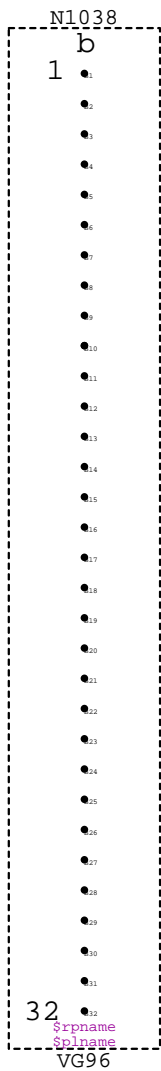

VG96\_B  
N????

VG96\_C  
N????

VG96U  
N????

X  
X????

X\_2MM\_4  
N????

X\_2MM\_30  
N????

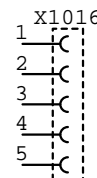
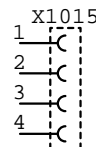
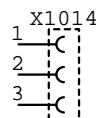
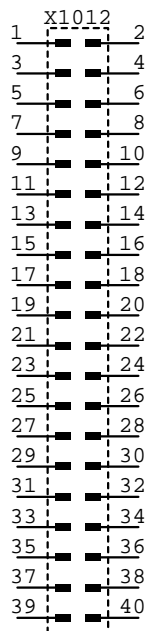
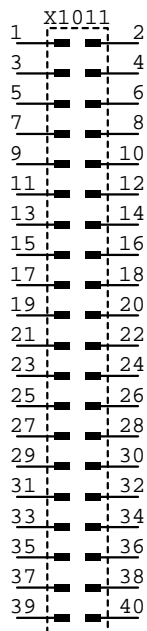

X\_AMPFH\_B\_40  
X????

X\_AMPFH\_S\_40  
X????

X\_B1R2P  
X????

X\_B1R3P  
X????

X\_B1R4P  
X????

X\_B1R5P  
X????

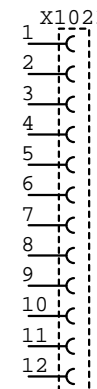
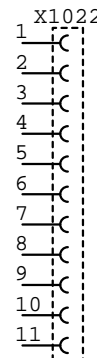
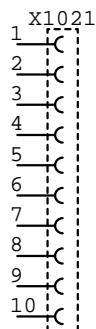
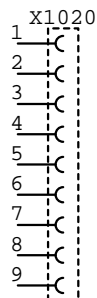
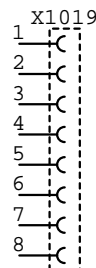
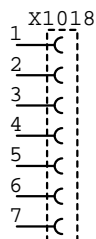
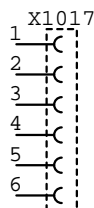

X\_B1R6P  
X????

X\_B1R7P  
X????

X\_B1R8P  
X????

X\_B1R9P  
X????

X\_B1R10P  
X????

X\_B1R11P  
X????

X\_B1R12P  
X????

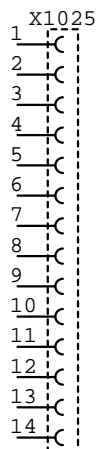
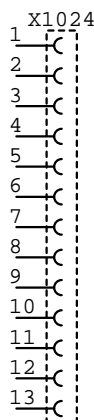

X\_B1R13P  
X????

X\_B1R14P  
X????



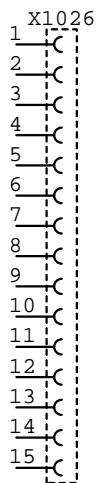

X\_B1R15P  
X?????

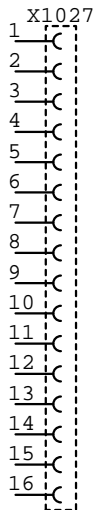

X\_B1R16P  
X?????

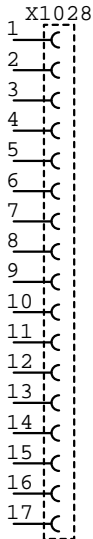

X\_B1R17P  
X?????

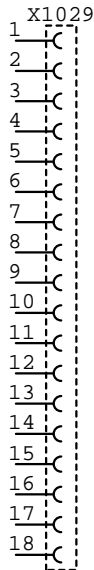

X\_B1R18P  
X?????

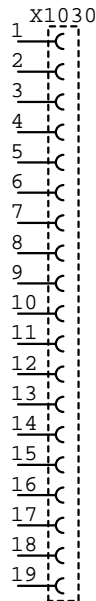

X\_B1R19P  
X?????

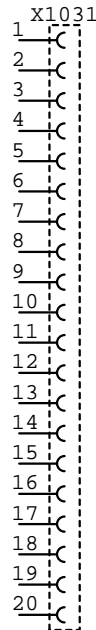

X\_B1R20P  
X?????

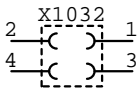

X\_B2R4P  
X?????

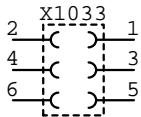

X\_B2R6P  
X?????

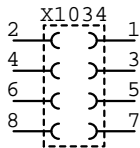

X\_B2R8P  
X?????

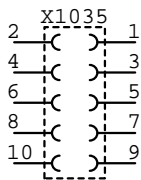

X\_B2R10P  
X?????

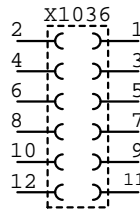

X\_B2R12P  
X?????

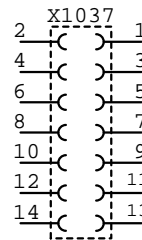

X\_B2R14P  
X?????

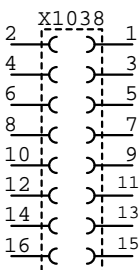

X\_B2R16P  
X?????

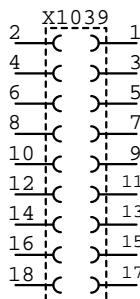

X\_B2R18P  
X?????

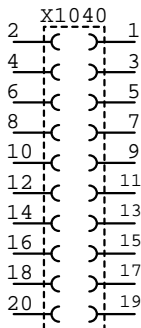

X\_B2R20P  
X?????

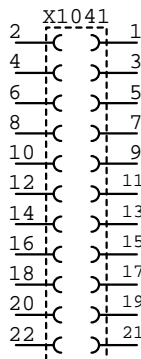

X\_B2R22P  
X?????

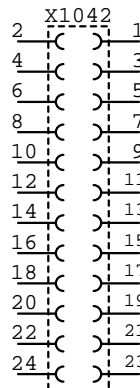

X\_B2R24P  
X?????

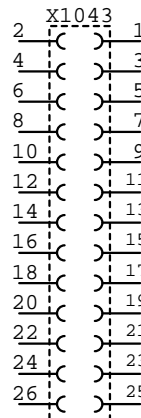

X\_B2R26P  
X?????

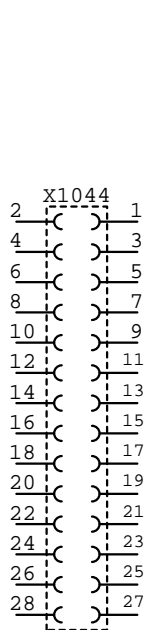

X\_B2R28P  
X?????

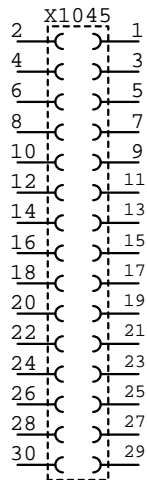

X\_B2R30P  
X?????

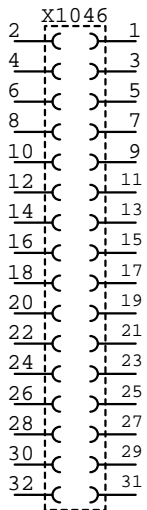

X\_B2R32P  
X?????

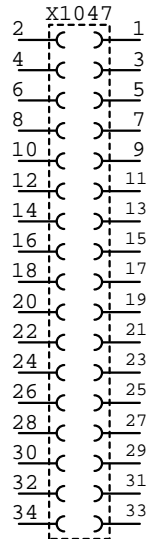

X\_B2R34P  
X?????

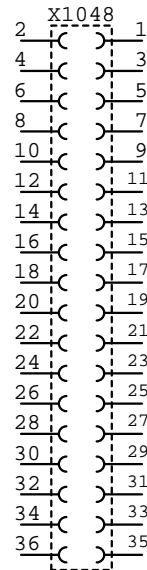

X\_B2R36P  
X?????

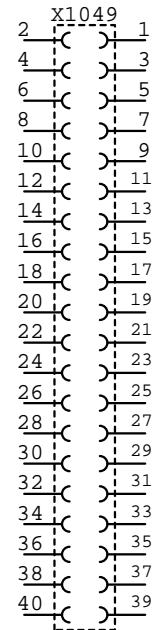

X\_B2R40P  
X?????

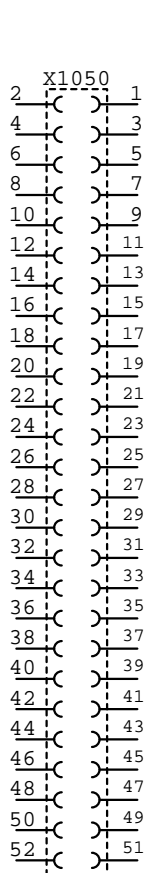

X\_B2R52P  
X?????

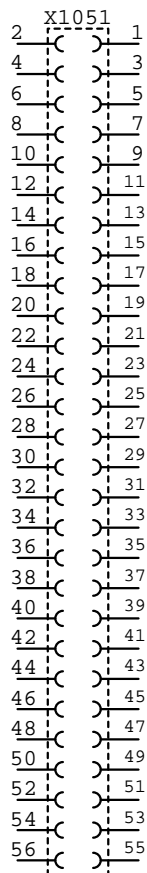

X\_B2R56P  
X?????

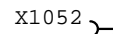

X\_BAT  
X?????

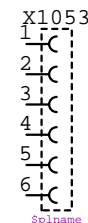

X\_BUST1R6AP  
X?????

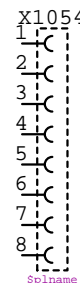

X\_BUST1R8AP  
X?????

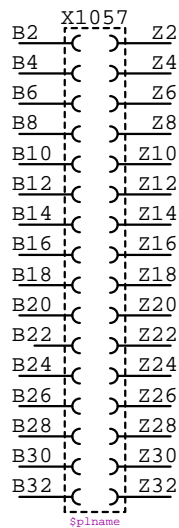
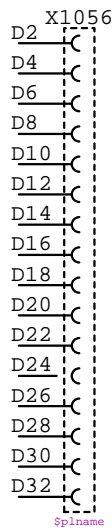
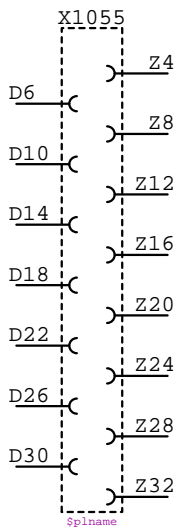

X\_FEDERL15DZ  
X?????

X\_FEDERL16D  
X?????

X\_FEDERL32BZ  
X?????

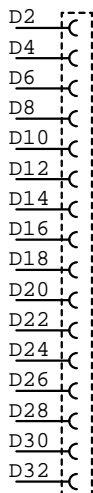

Federleiste X1058  
Splname

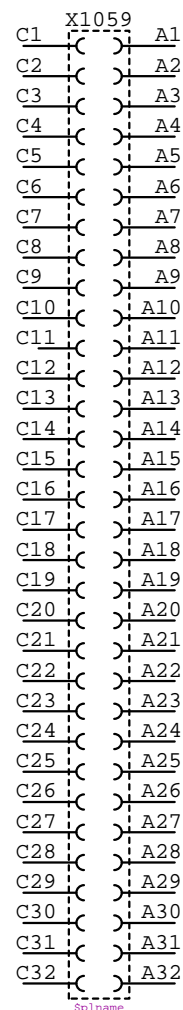
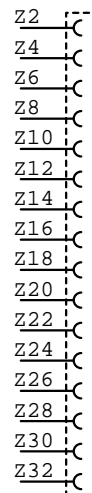
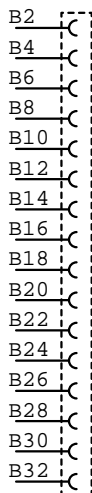

X\_FEDERL48DBZ  
X?????

X\_FEDERL64AC  
X?????

Federleiste X1060

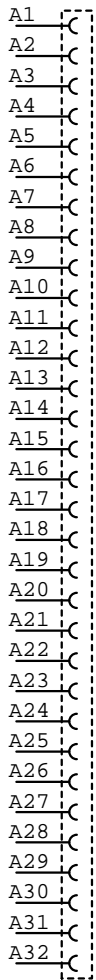

Spiname

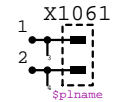
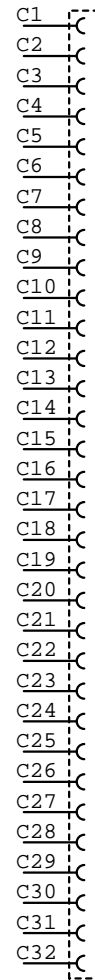
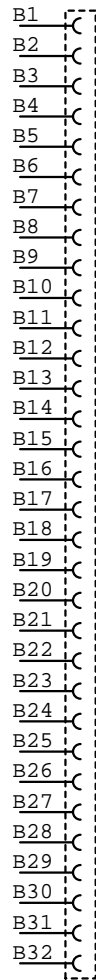

X\_FEDERL96ABC

X?????

X\_FLST1R2A4P

X?????

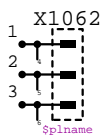

X\_FLST1R3A6P

X?????

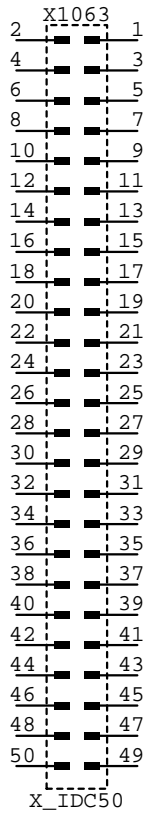

X\_IDC50  
X????

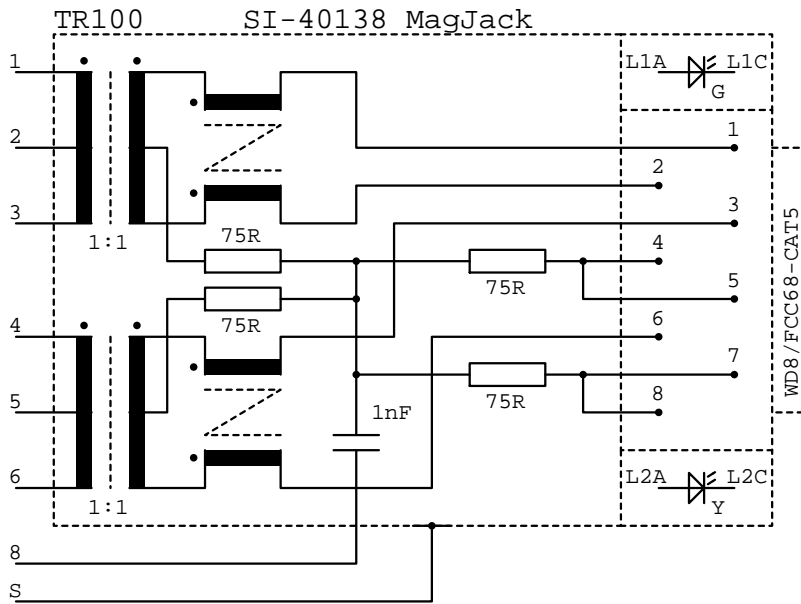

X\_MAGJACK  
TR???

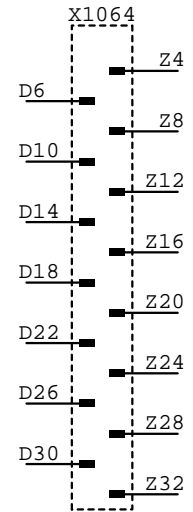

X\_ML15DZ  
X????



X\_ML16D  
X????

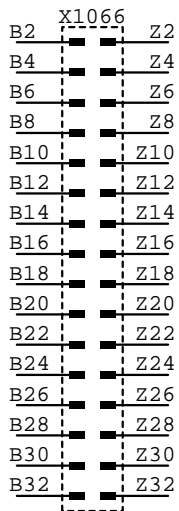

X\_ML32BZ  
X????

X1068		
C1		A1
C2		A2
C3		A3
C4		A4
C5		A5
C6		A6
C7		A7
C8		A8
C9		A9
C10		A10
C11		A11
C12		A12
C13		A13
C14		A14
C15		A15
C16		A16
C17		A17
C18		A18
C19		A19
C20		A20
C21		A21
C22		A22
C23		A23
C24		A24
C25		A25
C26		A26
C27		A27
C28		A28
C29		A29
C30		A30
C31		A31
C32		A32

Messerleiste X1067

D2
D4
D6
D8
D10
D12
D14
D16
D18
D20
D22
D24
D26
D28
D30
D32

B2
B4
B6
B8
B10
B12
B14
B16
B18
B20
B22
B24
B26
B28
B30
B32

Z2
Z4
Z6
Z8
Z10
Z12
Z14
Z16
Z18
Z20
Z22
Z24
Z26
Z28
Z30
Z32

X\_ML64AC  
X?????

X\_ML48DBZ  
X?????

Messerleiste X1069

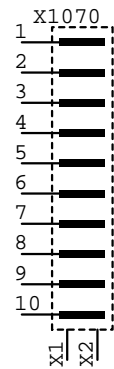
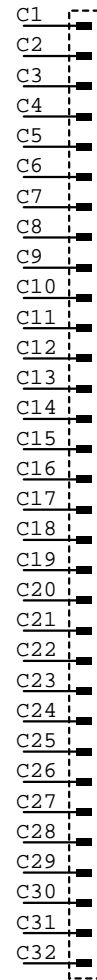
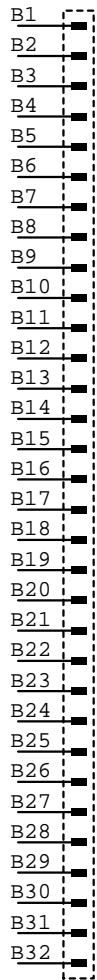
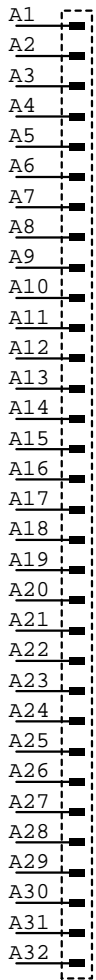

X\_ML96ABC  
X????

X\_MXFPC10\_10L  
X????

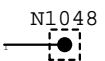
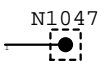
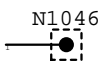
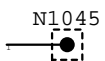
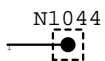
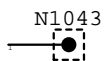

X\_PAD08K  
N????

X\_PAD08N  
N????

X\_PAD10N  
N????

X\_PAD11N  
N????

X\_PAD13G  
N????

X\_PAD13K  
N????

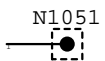
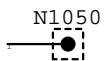
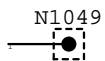

X\_PAD13N  
N????

X\_PAD16K  
N????

X\_PAD16N  
N????

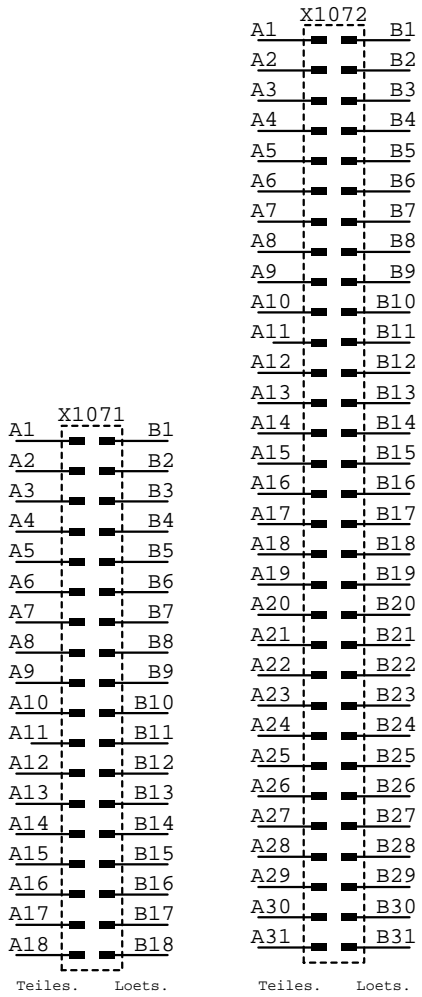

X\_PCS2X18P  
X?????

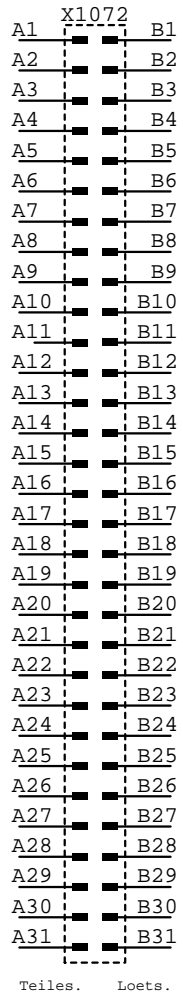

X\_PCS2X31P  
X?????

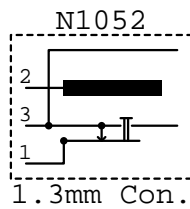

X\_POW13MM\_A  
N?????

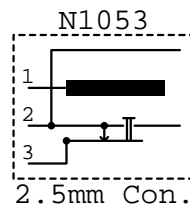

X\_POW25MM\_A  
N?????

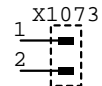

X\_S1R2P  
X?????

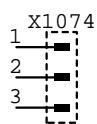

X\_S1R3P  
X?????

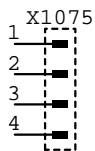

X\_S1R4P  
X?????



X\_S1R5P  
X?????

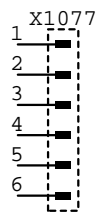

X\_S1R6P  
X?????



X\_S1R7P  
X?????



X\_S1R8P  
X?????

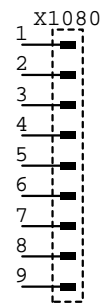

X\_S1R9P  
X?????



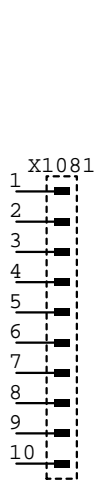

X\_S1R10P  
X????

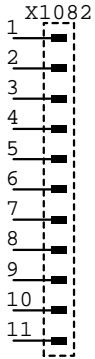

X\_S1R11P  
X????

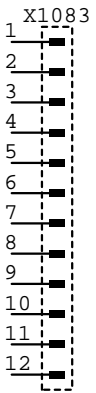

X\_S1R12P  
X????

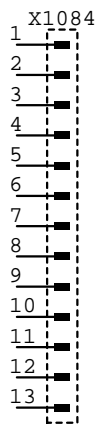

X\_S1R13P  
X????



X\_S1R14P  
X????

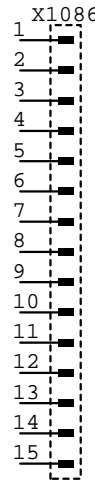

X\_S1R15P  
X????

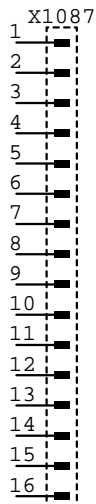

X\_S1R16P  
X????

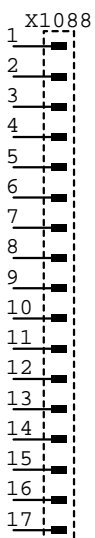

X\_S1R17P  
X????



X\_S1R18P  
X????

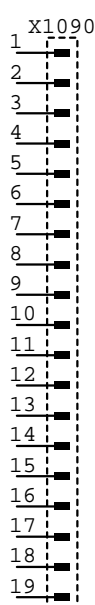

X\_S1R19P  
X????

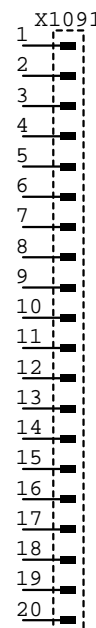

X\_S1R20P  
X????

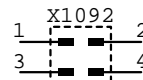

X\_S2R4P  
X????

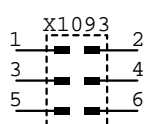

X\_S2R6P  
X????

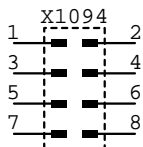

X\_S2R8P  
X????

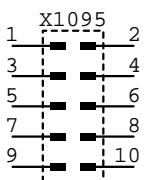

X\_S2R10P  
X????

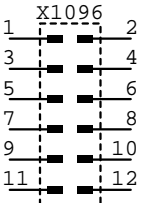

X\_S2R12P  
X????

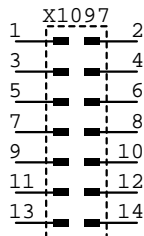

X\_S2R14P  
X????

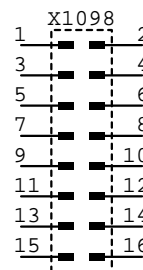

X\_S2R16P  
X????

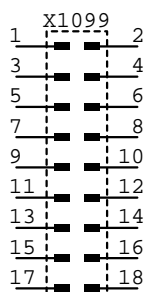

X\_S2R18P  
X?????

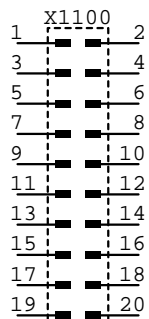

X\_S2R20P  
X?????

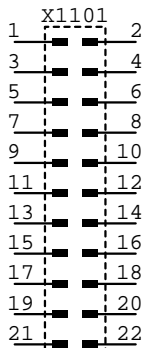

X\_S2R22P  
X?????

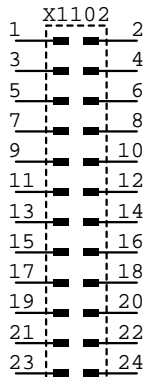

X\_S2R24P  
X?????

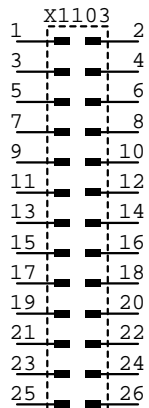

X\_S2R26P  
X?????

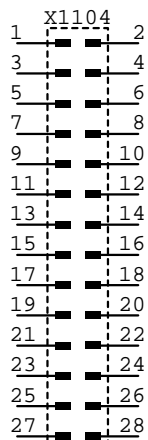

X\_S2R28P  
X?????

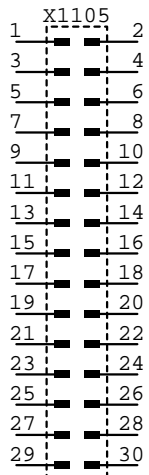

X\_S2R30P  
X?????

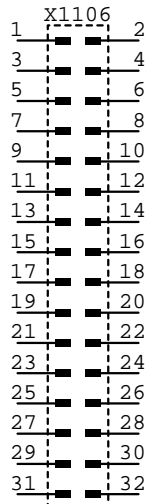

X\_S2R32P  
X?????

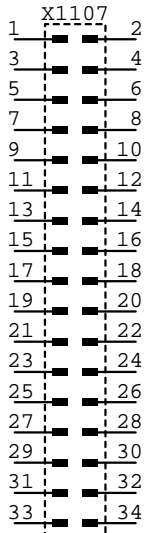

X\_S2R34P  
X?????

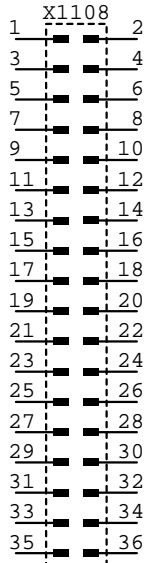

X\_S2R36P  
X?????

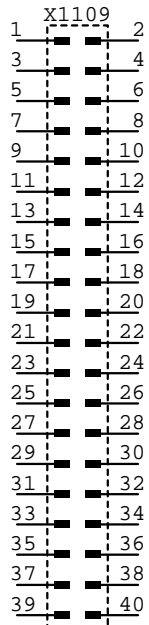

X\_S2R40P  
X?????

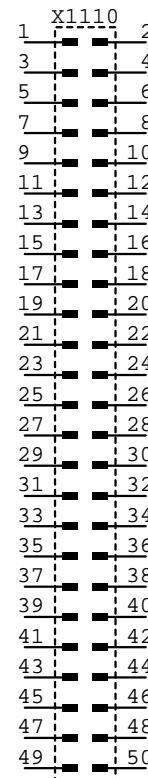

X\_S2R50P  
X?????

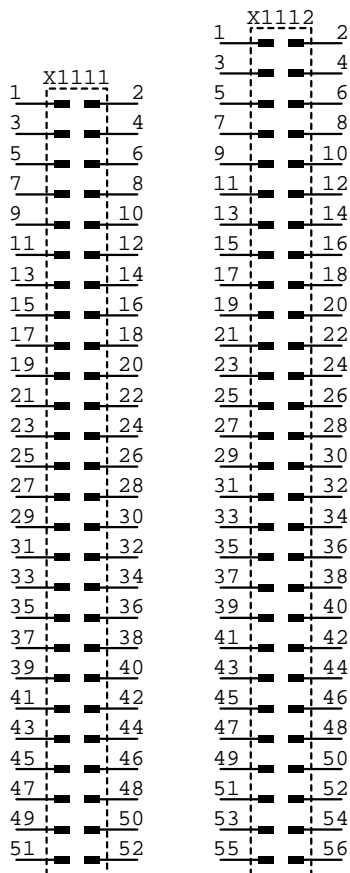

X\_S2R52P  
X?????

X\_S2R56P  
X?????



X\_SCHR1R1A2P  
X?????



X\_SCHR1R2AP  
X?????

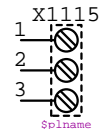

X\_SCHR1R3AP  
X?????

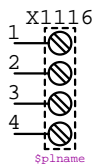

X\_SCHR1R4AP  
X?????

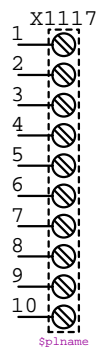

X\_SCHR1R10API  
X?????

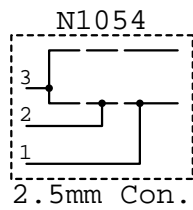

X\_STEREO25MM\_A  
N?????

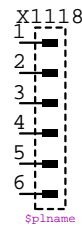

X\_STST1R6AP  
X?????

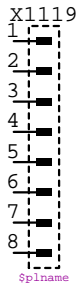

X\_STST1R8AP  
X?????

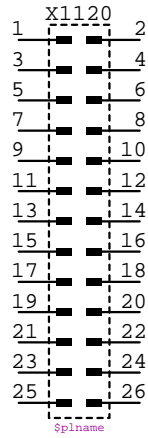

X\_STST2R26AP  
X?????

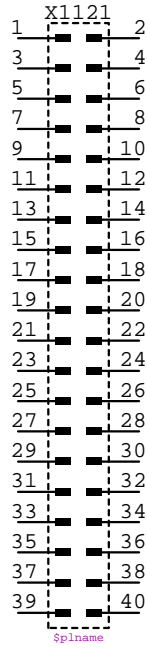

X\_STST2R40AP  
X?????

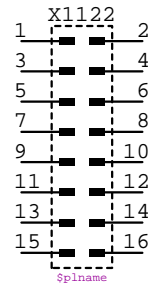

X\_STWA2R16AP  
X?????

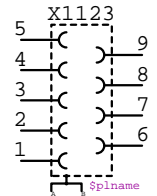

X\_SUBD9B  
X?????

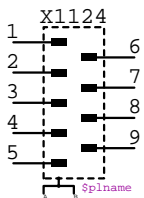

X\_SUBD9S  
X?????

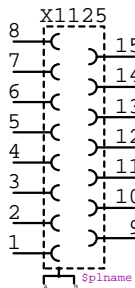

X\_SUBD15B  
X?????

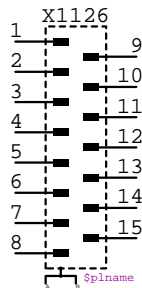

X\_SUBD15S  
X?????

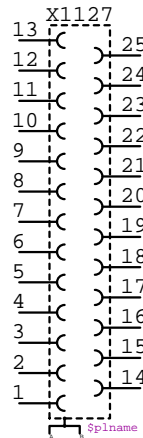

X\_SUBD25B  
X?????

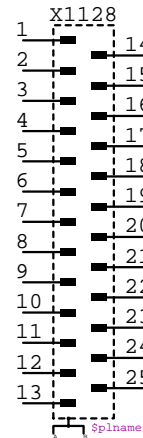

X\_SUBD25S  
X?????

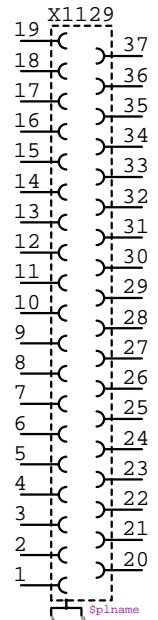

X\_SUBD37B  
X?????

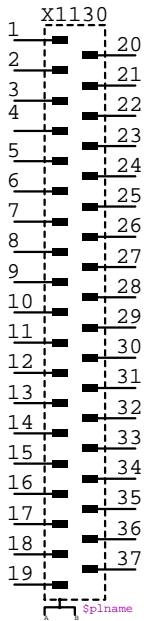

X\_SUBD37S  
X?????



X\_WAGO2SCHR508S  
X?????

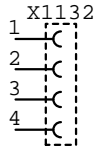

X\_WAGO4SCHR508S  
X?????

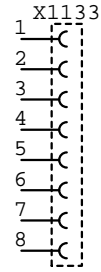

X\_WAGO8SCHR508S  
X?????

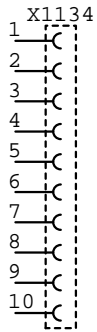

X\_WAGO10SCHR508S  
X?????

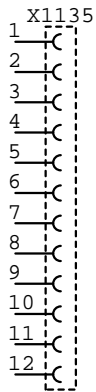

X\_WAGO12SCHR508S  
X?????

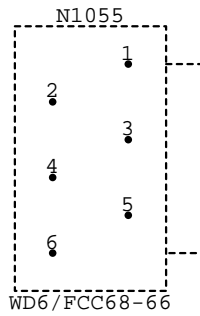

X\_WD6CON  
N?????

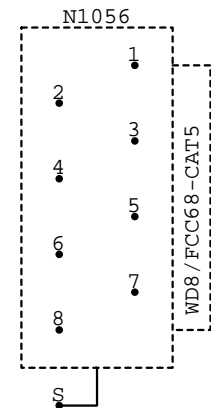

X\_WD8CAT5  
N?????

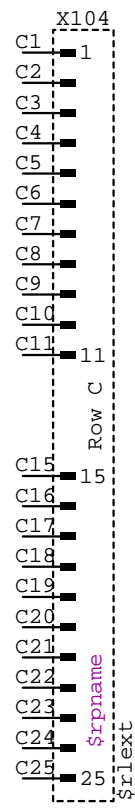
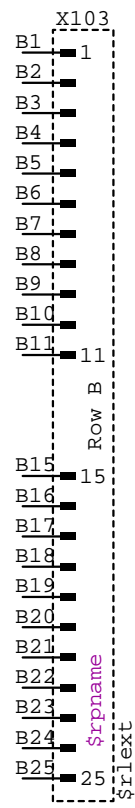
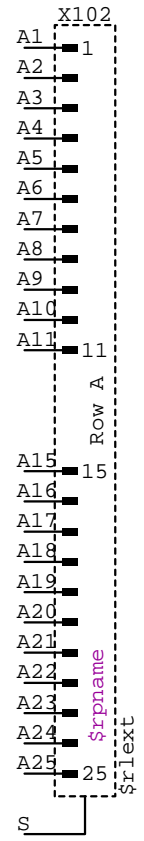
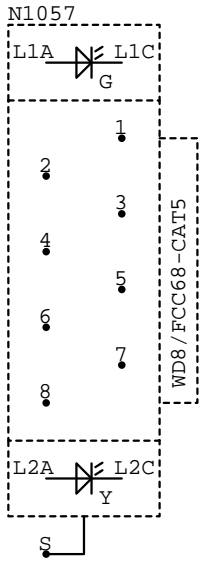

X\_WD8REV\_LED  
N????

X\_ZPACK\_A110\_A  
X???

X\_ZPACK\_A110\_B  
X???

X\_ZPACK\_A110\_C  
X???

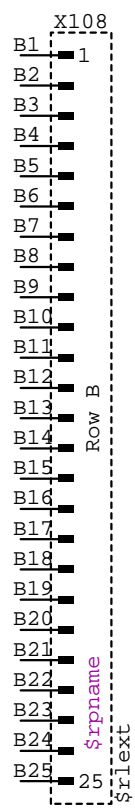
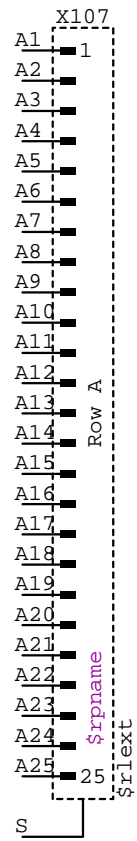
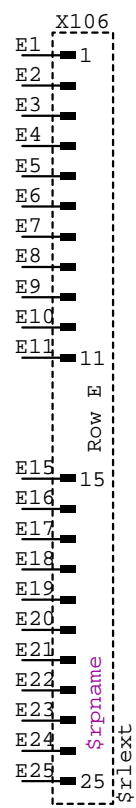
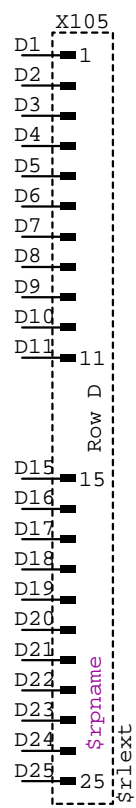

X\_ZPACK\_A110\_D  
X???

X\_ZPACK\_A110\_E  
X???

X\_ZPACK\_B125\_A  
X???

X\_ZPACK\_B125\_B  
X???

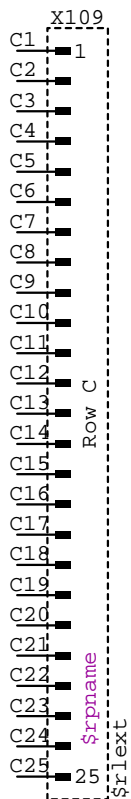

X\_ZPACK\_B125\_C

X???



X\_ZPACK\_B125\_D

X???

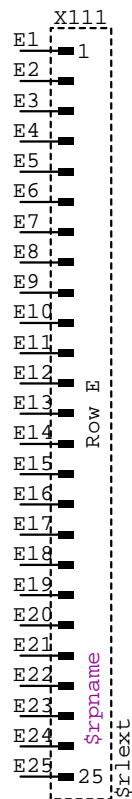

X\_ZPACK\_B125\_E

X???

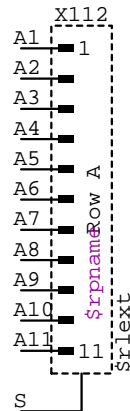

X\_ZPACK\_C55\_A

X???

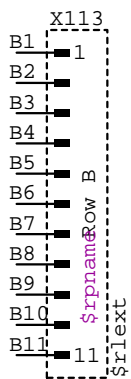

X\_ZPACK\_C55\_B

X???

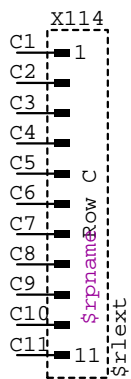

X\_ZPACK\_C55\_C

X???

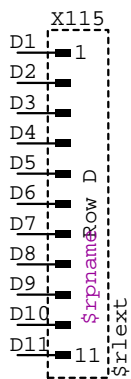

X\_ZPACK\_C55\_D

X???

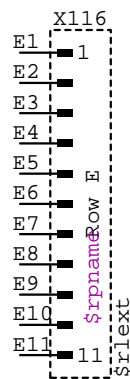

X\_ZPACK\_C55\_E

X???

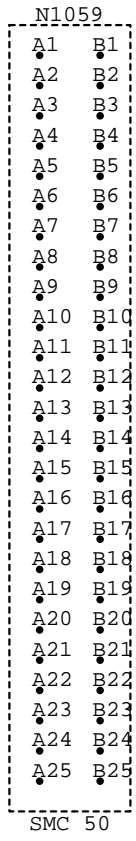
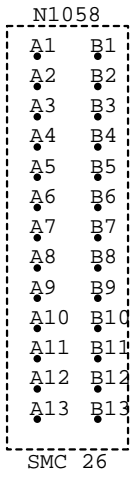

XERNISMC26SD

XERNISMC50SD

N????

N????